

OPERATOR

MRC-M

230 V

20M 30M 40M 50M



850MRC20M

230 V Tubular motor, hand crank function, Ø 45 mm, c/w bracket and adapters for tube Ø 70 mm 20 N m torque.

850MRC30M

230 V Tubular motor, hand crank function, Ø 45 mm, c/w bracket and adapters for tube Ø 70 mm 30 N m torque.

850MRC40M

230 V Tubular motor, hand crank function, Ø 45 mm, c/w bracket and adapters for tube Ø 70 mm 40 N m torque.

850MRC50M

230 V Tubular motor, hand crank function, Ø 45 mm, c/w bracket and adapters for tube Ø 70 mm 50 N m torque.

Application chart for awnings

ARM WITH 15 kg POWER

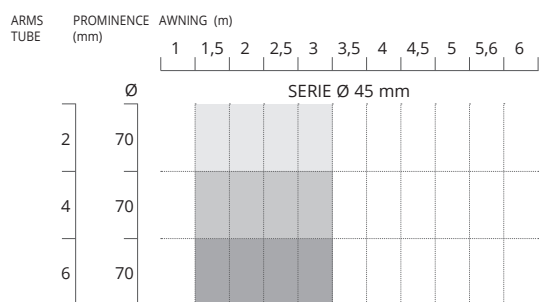

ARM WITH 25 kg POWER

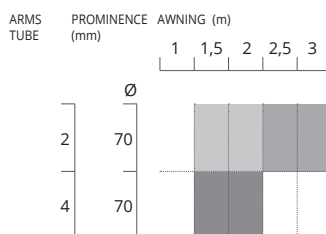

ARM WITH 35 kg POWER

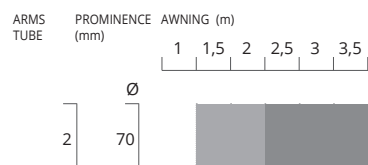

ARM WITH 45 kg POWER

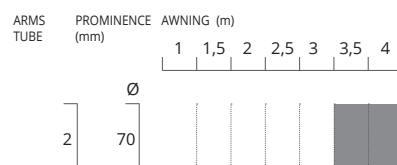

References

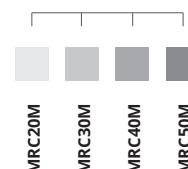



MADE IN ITALY

FEATURES:

- tubular motor Ø 45 mm
- 230 V motor
- built-in hand crank function
- self-braking motor
- max. run time 4'

PROS:

- ideal for awnings' projection up to 4 m
- quick installation
- easy setting of limit switches
- emergency manual operation thanks to the optional hand crank
- easy limit switch setting

Technical features	MRC20M	MRC30M	MRC40M	MRC50M
Degree of protection	IP 44			
Power supply	230 V AC (50 - 60 Hz)			
Absorption	0,92 A	1,1 A	1,3 A	1,4 A
Absorbed power	205 W	230 W	292 W	308 W
Crown Speed	13 rpm	13 rpm	13 rpm	13 rpm
Lifting Power	38 kg	56 kg	76 kg	94 kg
Operating temperature	-10° C ÷ +60° C			
Operating time	4 min			
Torque	20 N m	30 N m	40 N m	50 N m

DISEGNI TECNICI

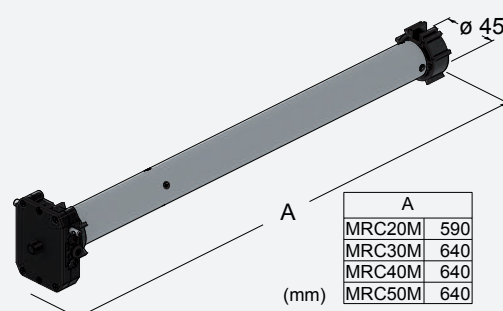

ACCESSORIES



850AD70C
Replacement crown drive adapter kit for tube Ø 70 mm



850CSVP
Weather station



850SND45C
45°/90° hand crank loop for shutter box



850ANCP
45°/90° hand crank loop for shutter box

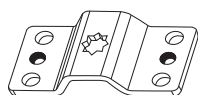

850DZ68
45°/90° hand crank loop for shutter box



850PLV
Rain sensor



850MAN150
Steel hand crank, 1500 mm, with joint arm



850OCC
Hand crank loop