

AUTOMATIC BARRIER

RBLO

12
VOLT

For barrier boom length up to 4 m
Opening time 2,2 sec.

800RBLO Dx/Sx

Fast DC barrier for round or elliptical booms up to 4 m complete with built-in electronic control unit, 433,92 Mhz rolling code radio receiver and battery charger. Painted steel cabinet. Boom, spring and boom fixing support to be ordered separately

800RBLO-I Dx/Sx

Fast DC barrier for round or elliptical booms up to 4 m complete with built-in electronic control unit, 433,92 Mhz rolling code radio receiver and battery charger. Stainless steel cabinet. Boom, spring and boom fixing support to be ordered separately

Boom, spring and boom fixing support are compulsory accessories of the automatic barrier.
See page 96.

Features:

- residential / commercial use
- for booms up to 4 m
- opening time 2,2 seconds

Pros:

- intensive use
- fast opening
- ideal for busy entrances and car parks
- it works even during power cuts thanks to the optional back-up battery kit
- possibility to install photocells and flashing lights directly on the barrier cabinet
- in accordance with EN 12453 standards
- self-adjusting gate stroke through optical encoder

Technical features

RBLO - RBLO-I

Power supply	230 V AC (50 - 60 Hz)
Motor power supply	18 V DC
Absorption	1 A
Power rating	250 W
Min. opening time 90°	2,2 sec.
Duty cycle	100 %
Max. torque	155 Nm
Operating temperature	-20° C ÷ +55° C
Degree of protection	IP 54
Max width of passage clearance	4 m
Electronic control unit	K206MA
Endurance test	more than 1.000.000 opening and closing maneuvers

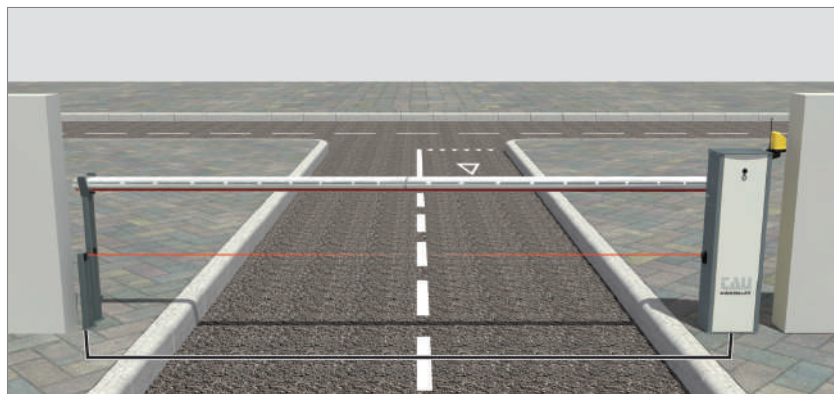

The above represented installation does not include safety devices such as safety edges. Their addition depends upon the risk assessment made on any installation in accordance with EN 12453 standards.

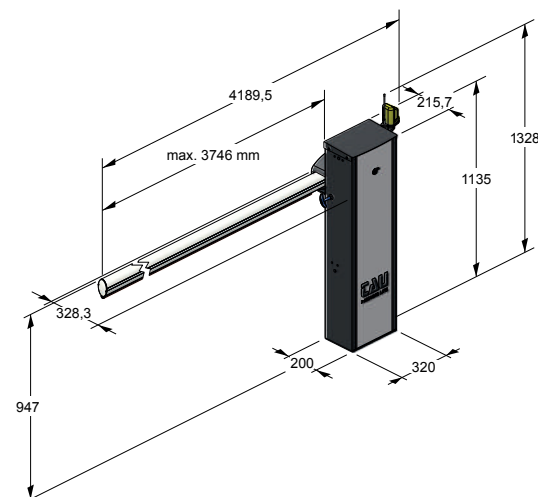

RBLO - RBLO-I

Round boom accessories



800ABT1
Anodized aluminium round section telescopic boom \varnothing 75 mm, 3 m, c/w adhesive refractor strips



800AFI3
3 m anodized aluminium \varnothing 70 mm round section boom with red adhesive refractor strips



800AFI4
Anodized aluminium round section boom \varnothing 70 mm, 4 m, complete with adhesive refractor strips



800RBLO-L041
Fixing support for \varnothing 75 mm round boom 800ABT. Plastic cover included



800RBLO-L052
Fixing support for \varnothing 70 mm round boom 800AFI. Plastic cover included



800SFA
Boom break-out system

Elliptical boom accessories



800AE2
Elliptical white painted aluminium boom, 2 m. Flashing LED lights and rubber bead to be ordered separately



800AE3
Elliptical white painted aluminium boom, 3 m. Flashing LED lights and rubber bead to be ordered separately



800AE4
Elliptical white painted aluminium boom, 4 m. Flashing LED lights and rubber bead to be ordered separately



800RBLO-L043
Elliptical boom fixing support for booms up to 4m. Plastic cover included



800LARG4*
LED flashing lights (red&green) for both sides of the boom. Single piece 8 m long.



800LA4
LED flashing lights for both sides of the boom. Single piece 8 m long.



800PG4
4 m rubber bead for elliptical boom



800XABTSE
Joint for elliptical boom



800XSFA
Boom break-out system for elliptical boom max 3 m. (Not usable in the presence of: 800ATE/800ATR/800AT)



800ATE
Boom support with electromagnet



800FPL
Pendulum boom support. For boom max 3,5 m.

Accessories for RBLO, RBLO-R and RBLO-E



800ATR
Adjustable boom support. Maximum height 955 mm

NEW



800AT
Fixed boom support h 865 mm



800CPRBL
Counterplate (RBLO)



900TOWERF
Photocells mounting post



900OPTIC
Set of safety photocells



300SA1
Magnetic loop detector



250SM126
Memory card for 126 radio codes (RBLO)



250SM254
Memory card for 254 radio codes (RBLO)



250SM1022
Memory card for 1022 radio codes (RBLO)



900T-COMM
Interface to connect two control units as Master/Slave (Activation through TAUPROG handheld device).



200BATT
12 V back-up battery, 7,2 Ah with cable (RBLO-E excluded)



M-030KITKB20
Battery cables kit (20 pcs) (RBLO-E excluded)



900VLED-AT
230 V AC neutral led flashing light (RBLO-E)



900VLED
Low voltage 12-18-24 Volt neutral led flashing light

* It is possible to programme its operation through TAUPROG or TauApp handheld device

Springs



M-060MGREEN
Spring wire dia. 5,2 mm, load
90 kg (green)



M-060MBLU
Spring wire dia. 6,2 mm, load
155 kg (Blue)



M-060MGREENL
Spring wire dia. 4,2 mm, load 50
kg (light green)



M-060MYELLOW
Spring wire dia. 9 mm, load 370
kg (yellow)



M-060MRED
Spring wire dia. 7 mm,
load 185 kg (red)

Springs for round booms

SPRING	A)	M-060MGREENL (ø 4,2 mm) Color: Light green RAL 6019	B)	M-060MGREEN (ø 5,2 mm) Color: Green RAL 6002
	C)	M-060MBLU (ø 6,2 mm) Color: Blue RAL 5003	D)*	M-060MRED (ø 7 mm) Color: Red RAL 3000

BAR AND ACCESSORIES	BAR LENGTH				
	2 m	2,5 m	3 m	3,5 m	4 m
800AFI4 (RBLO) / 800ABT1 (RBLO-E)	A	A			
800AFI4 (RBLO) / 800ABT1 (RBLO-E) + 800AT	A	A	B	C	D

The RBLO-E barrier is supplied as standard with the "B" spring (M-060MGREEN), suitable for booms up to 3 m. For different boom lengths or when further optionals are to be installed please order a different spring as per enclosed chart.

For boom lengths equal or greater than 3 mt. it MUST USE (compulsory) the ground boom support or the pendulum support.

Springs for elliptical booms

SPRING	A)	M-060MGREENL (ø 4,2 mm) Color: Light green RAL 6019	B)	M-060MGREEN (ø 5,2 mm) Color: Green RAL 6002	C)	M-060MBLU (ø 6,2 mm) Color: Blue RAL 5003
	D)*	M-060MRED (ø 7 mm) Color: Red RAL 3000	E)	M-060MYELLOW (ø 9 mm) Color: Yellow RAL 1004		

BAR AND ACCESSORIES	BAR LENGTH				
	2 m	2,5 m	3 m	3,5 m	4 m
800AE	A	A	-	-	-
800AE + 800AT	A	A	C	D	D*
800AE + 800FPL	-	-	-	D*	-
800AE + 800AT + 800XABTSE	-	-	E	E	E

* Eyelet in max. load position

For different boom lengths or when further optionals are to be installed please order a different spring as per enclosed chart.

For boom lengths equal or greater than 3 mt. it MUST USE (compulsory) the ground boom support or the pendulum support.

ATTENTION: FOR ELLIPTIC BOOM IS REQUIRED THE RUBBER PROFILE (800PG4 - 800PG8).

How to determine the barrier version

Right-hand version

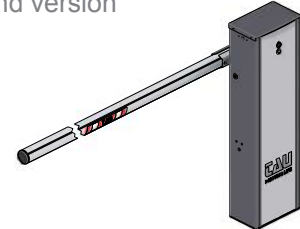

Left-hand version



Easy-to-operate, intuitive manual release with key lock for the less skilled users



Further accessories:
Transmitters page 118
Photocells page 124
Flashing lights page 127

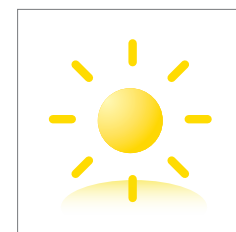

Solar power
Thanks to the Photovoltaic (PV) Technology, every low voltage DC gate operator can be solar powered. Discover the advantages of the solar energy at page 138