

DOOR OPENER T-LINE

DC
MOTOR

Max. wing weight :
1 wing: 150 kg
2 wings: 130+130 kg

Opening
speed
70 cm/s



T-LINE is TAU's automation for pedestrian sliding doors. It is conceived for busy environments, where a fast opening speed is required, as well as for domestic environments, where softer and more controlled movements are needed. Thanks to its simple and elegant design, the silent T-LINE automation can easily match any type of house furniture.

T-LINE automatic sliding door is easy to install and control, thanks to some smart devices such as the self-support beam and its cover.

Every automation system must be completed with opening, safety and control devices according to the existing legislation.



**Accessories for
T-LINE series**
Page 178

FEATURES:

- commercial use
- emergency operation with integrated backup battery pack (optional)
- max. door panel weight 1 x 150 kg or 2 x 130 kg
- max. clear passage width 3100 mm
- in accordance with EN 16005 standards

PROS:

- intensive use
- ideal for offices, supermarkets, hospitals and busy environments
- obstacle detection and crush prevention
- large vertical (20 mm) and horizontal (36 mm) leaf adjustment range
- assisted cover opening

TYPES OF OPENING



DOUBLE LEAF

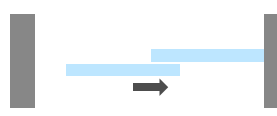

SINGLE LEAF
opening to the right



SINGLE LEAF
opening to the left

Technical features	1 LEAF T-LINE	DOUBLE LEAF T-LINE
Door opening width	700 ÷ 3200 mm	900 ÷ 3200 mm
Max leaf weight	150 kg	130 Kg +130 kg
Max automation sizes	160 x 120 x max. length 6500 mm	
Power	120 VA	
Power supply	230 V - 50Hz	
DC door operator power supply	48 V DC	
Outer accessories power supply	24 V DC - 24 V AC	
Opening speed	70 cm/s per leaf	
Closing speed	60 cm/s per leaf	
Adjustable pause time	0 ÷ 32 s	
Self-adjustment of the pause time	Si	
Reduced winter opening	standard 75% off opening width	
Operating temperature	-20°C ÷ +50°C	
Degree of protection	IP 22	
Duty cycle	100%	
Number of manoeuvres	1.000.000 manoeuvres test	
Safety test	Radar test function available as per EN 16005 requirements	
Interlock system	Available. A second TAU automatic door can only be opened after the closing of the first one	
Separate opening/closure inputs	Yes	
Type of use	Residential - Commercial - Industrial	

COMPONENTS OF T-LINE AUTOMATIC DOOR



SIDE HANDLE UNLOCKING DEVICE (optional)

It is possible to unlock the automation manually thanks to the simple and intuitive side handle. It can be placed to the left or to the right of the aluminium beam.



COMPACT SIZES

Easy to fit in any environment thanks to its small sizes (only 120 mm height and 157,5 mm width).



SILENT MOVEMENT

A track that lays on an anti-vibration gasket ensures a silent and flowing movement of the door.

The track can be replaced once worn out.

An additional sound control gasket has been placed between the beam and its cover in order to further reduce the impact of the vibrations.

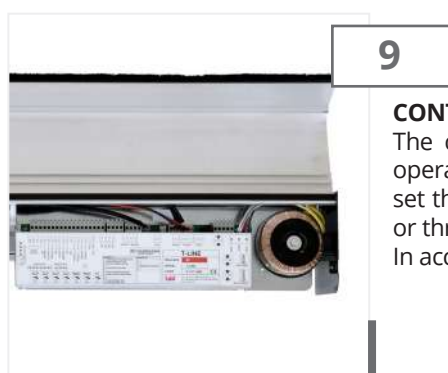
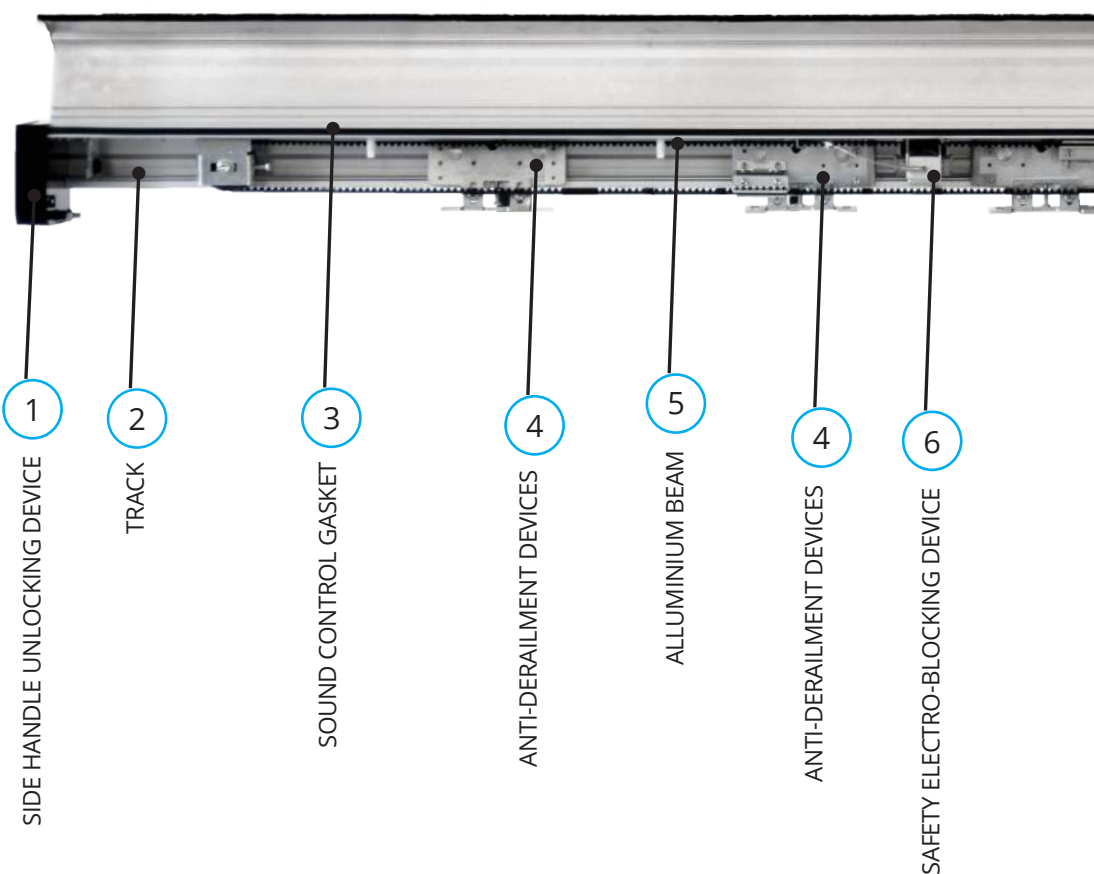

CONTROL BOARD

The control board is conceived to meet any operating need. Easy to programme, it can be set through simple trimmers and dip switches or through the optional digital keypad.

In accordance to EN-16005 standards.

4



ANTI-DERAILMENT DEVICES

The steady double wheel track rollers with a third anti-derailment wheel are conceived to sustain leaves that weigh up to 150 kg.

EASY AND QUICK INSTALLATION

Thanks to the practical aluminium anchor template, the beam can quickly and easily be fixed just by one person.

5

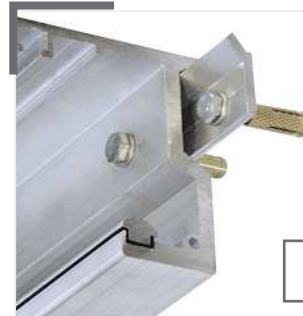

4

ANTI-DERAILMENT DEVICES

7

ALUMINIUM BEAM COVER

8

MOTOR WITH ENCODER

9

CONTROL BOARD



6

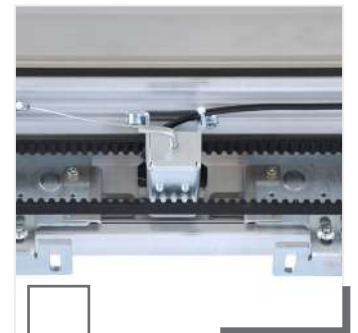

SAFETY ELECTRO-BLOCKING DEVICE

Manual emergency opening device simple and easy to activate thanks to the central or side handle. The optional electro-locking device ensures the closing of the door.

7

PRACTICAL

The aluminium beam cover can easily be opened. It can also remain lifted up to make the maintenance of the automation easier.



EVERYTHING UNDER CONTROL

A steady DC gate operator with optical encoder ensures and controls the movement of the door.



8

The single or double leaf automation includes: anodized aluminium beam, anodized aluminum cover, side caps, operator, belt, carriage assemblies and electronic control unit. The price of each automation refers to the maximum length of the beam and of the cover, but they can also be cut to the required size.

SINGLE LEAF AUTOMATIC SLIDING DOOR MAX 150 KG

Reference	Clear opening	Beam cut length	Max. leaf weight
10T-LINE1.195	900 mm	1950 mm	1 x 150 kg
10T-LINE1.215	1000 mm	2150 mm	1 x 150 kg
10T-LINE1.235	1100 mm	2350 mm	1 x 150 kg
10T-LINE1.255	1200 mm	2550 mm	1 x 150 kg
10T-LINE1.275	1300 mm	2750 mm	1 x 150 kg
10T-LINE1.295	1400 mm	2950 mm	1 x 150 kg
10T-LINE1.315	1500 mm	3150 mm	1 x 150 kg
10T-LINE1.335	1600 mm	3350 mm	1 x 150 kg
10T-LINE1.355	1700 mm	3550 mm	1 x 150 kg
10T-LINE1.375	1800 mm	3750 mm	1 x 150 kg
10T-LINE1.395	1900 mm	3950 mm	1 x 150 kg
10T-LINE1.415	2000 mm	4150 mm	1 x 150 kg
10T-LINE1.435	2100 mm	4350 mm	1 x 150 kg
10T-LINE1.455	2200 mm	4550 mm	1 x 150 kg
10T-LINE1.475	2300 mm	4750 mm	1 x 150 kg
10T-LINE1.495	2400 mm	4950 mm	1 x 150 kg
10T-LINE1.515	2500 mm	5150 mm	1 x 150 kg
10T-LINE1.535	2600 mm	5350 mm	1 x 150 kg
10T-LINE1.555	2700 mm	5550 mm	1 x 150 kg
10T-LINE1.575	2800 mm	5750 mm	1 x 150 kg
10T-LINE1.595	2900 mm	5950 mm	1 x 150 kg
10T-LINE1.615	3000 mm	6150 mm	1 x 150 kg
10T-LINE1.635	3100 mm	6350 mm	1 x 150 kg

DOUBLE LEAF AUTOMATIC SLIDING DOOR MAX 130+130 KG

Reference	Clear opening	Beam cut length	Max. leaf weight
10T-LINE2.215	1000 mm	2150 mm	2 x 130 kg
10T-LINE2.235	1100 mm	2350 mm	2 x 130 kg
10T-LINE2.255	1200 mm	2550 mm	2 x 130 kg
10T-LINE2.275	1300 mm	2750 mm	2 x 130 kg
10T-LINE2.295	1400 mm	2950 mm	2 x 130 kg
10T-LINE2.315	1500 mm	3150 mm	2 x 130 kg
10T-LINE2.335	1600 mm	3350 mm	2 x 130 kg
10T-LINE2.355	1700 mm	3550 mm	2 x 130 kg
10T-LINE2.375	1800 mm	3750 mm	2 x 130 kg
10T-LINE2.395	1900 mm	3950 mm	2 x 130 kg
10T-LINE2.415	2000 mm	4150 mm	2 x 130 kg
10T-LINE2.435	2100 mm	4350 mm	2 x 130 kg
10T-LINE2.455	2200 mm	4550 mm	2 x 130 kg
10T-LINE2.475	2300 mm	4750 mm	2 x 130 kg
10T-LINE2.495	2400 mm	4950 mm	2 x 130 kg
10T-LINE2.515	2500 mm	5150 mm	2 x 130 kg
10T-LINE2.535	2600 mm	5350 mm	2 x 130 kg
10T-LINE2.555	2700 mm	5550 mm	2 x 130 kg
10T-LINE2.575	2800 mm	5750 mm	2 x 130 kg
10T-LINE2.595	2900 mm	5950 mm	2 x 130 kg
10T-LINE2.615	3000 mm	6150 mm	2 x 130 kg
10T-LINE2.635	3100 mm	6350 mm	2 x 130 kg

T-LINE INSTALLATION KIT

FEATURES:

The components to assemble the door (beam, cover and so on) are supplied separately. Cutting and assembling operations are carried out by the customer. It is the best solution for customers that need to quickly fulfil orders of tailor-made doors.

PROS:

- competitive costs
- increased flexibility
- eliminates the need to stock complete door packages
- logistics optimization
- prompt delivery to the end-user of a customized door package



TLINEKIT1.150

Single leaf sliding door opener (max 150 kg)

TLINEKIT2.130

Double leaf sliding door opener (max 130 + 130 kg)

The beam and its cover can also be supplied in anodized aluminium (natural aluminium colour) upon request just before the order, with a 20% increase on the pricelist.

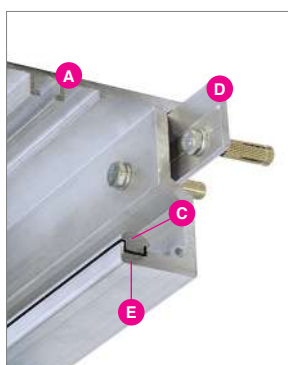
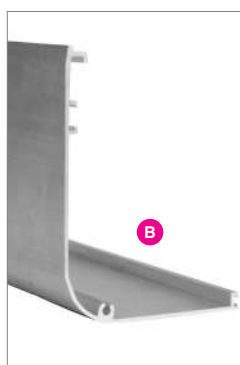

A) S-10T-LINETRA65

T-Line support beam / = 6500 mm

B) S-10T-LINECAR65AN

Front cover profile in anodized aluminum T-Line / = 6500 mm

C) S-10T-LINEROT65

T-Line track / = 6500 mm

D) S-10T-LINEANK65

T-Line anchor template / = 6500 mm

E) S-10T-LINEANR

Anti-vibration gasket for T-Line track. (200 m)

F) M-0300000380

Extruded rubber (100 m)

G) S-T-LINEGUM

38 mm rubber gasket

H) S-10DOORCING

Traction belt (50 m)

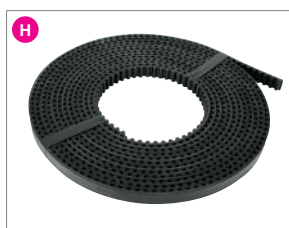
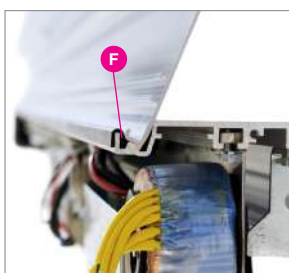



FRAME BREAK-OUT SYSTEM FOR SLIDING DOORS

It is the best certified solution when the automatic door is also the only emergency exit. Such system ensures the outward swing opening of the door when pushed.

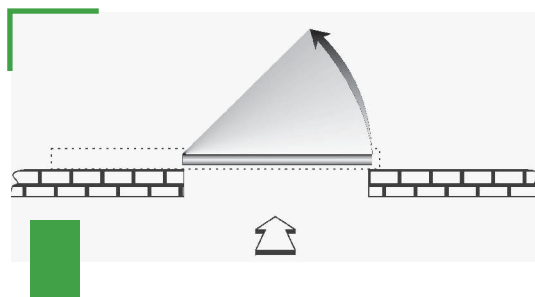

S-10DOORSF1M

Configuration: single sliding with fixed sidelight panels. Frame break-out system composed of 1 x break-out kit, 1 x upper profile 1300 mm, 1 x floor track 1400 mm. Specify right or left-hand (consult TAU for additional information)

N.B. : The automation is fixed on the outside of the door's structure

Additional components (to be purchased separately):

S-10DOORFOTOG Pair of safety photocells (if a set of DOORFOTO1 is already installed)
S-10DOORSTF Metal housing for DOORFOTOG

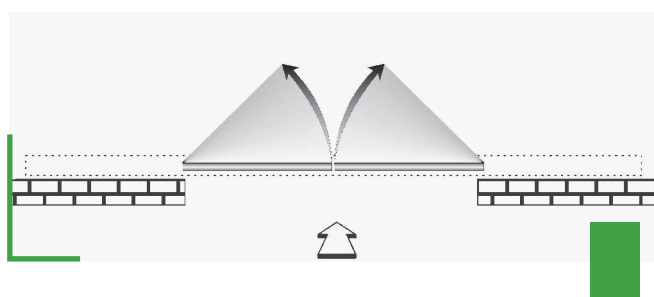

10DOORSF2M

Configuration: bi-parting with fixed sidelight panels. Frame break-out system composed of 2 x break-out kits, 2 x upper profiles 1300 mm, 2 x floor tracks 1400 mm

N.B. : The automation is fixed on the outside of the door's structure.

Additional components (to be purchased separately):

S-10DOORFOTOG Pair of safety photocells (if a set of DOORFOTO1 is already installed)
S-10DOORSTF Metal housing for DOORFOTOG

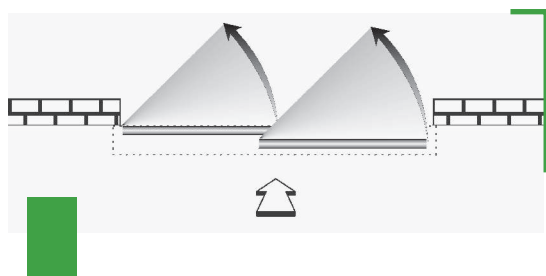

S-10DOORSF2MF

Configuration: single sliding with break-out sidelight panel. Frame break-out system composed of 1 x break-out kit, 1 x upper profile 1300 mm, 1 x floor track 1400 mm, 1 x ball-lock, 1 x magnetic contact. Specify right or left-hand (consult TAU for additional information)

Additional components (to be purchased separately):

S-10DOORSQ2 Lock brackets to prevent opening from the outside (2 pcs)
S-10DOORCRN2 1 pair of hinges
S-10DOORGP Cable sheath for photocell
S-10DOORGPS Retractable cable sheath for photocell

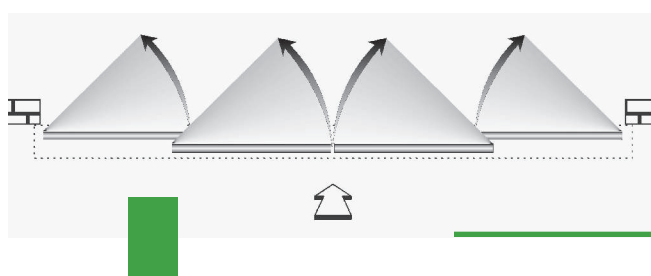

S-10DOORSF4MF

Configuration: bi-parting with break-out sidelight panels. Frame break-out system composed of 2 x break-out kits, 2 x upper profiles 1300 mm, 2 x floor tracks 1400 mm, 2 x ball-locks, 2 x magnetic contact

Additional components (to be purchased separately):

S-10DOORSQ4 Lock brackets to prevent opening from the outside (4 pcs)
S-10DOORCRN4 2 pairs of hinges
S-10DOORGP2 Cable sheath for photocell (2 pcs)
S-10DOORGPS2 Retractable cable sheath for photocell (2 pcs)

ACCESSORIES

ACCESSORIES



S-10DOORRAD2
Radar for activation and safety
compliant EN16005



S-10DOORRAD/STA
Radar for active infrareds. Narrow field
for lateral security



S-10DOORRAD
Active infrared motion detector



S-10DOORFOTOG
Pair of safety photocells



S-10DOORADM
Microwave radar detector, scanned area
4 m



S-10DOORADMU
Microwave radar detector, unidirectional,
scanned area 4 m



S-10T-LINESELF
Key function selector

NEW



S-10T-LINESELF
Function selector



S-10DOORTL
Microwave, hygienic, touchless,
automatic door activation switch,
scanned area 4 m, 3 different faceplates
included



S-10T-LINETD
Digital key pad



10T-LINEANT10
1 m support kit for framed leaf



S-10T-LINECRIS10
Aluminium clamp for frameless glass panels
(thickness 10 mm), length 1 m

10T-LINEANT15
1,5 m support kit for framed leaf

S-10T-LINECRIS15
Aluminium clamp for frameless glass panels
(thickness 10 mm), length 1,5 m

10T-LINEANT20
2 m support kit for framed leaf

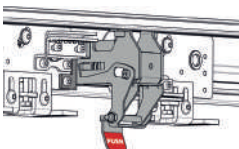

S-10T-LINEBLOCL
Electromechanical lock with center
release (It can be used on automatic
doors with framed leaves with a
maximum thickness of 50 mm)



S-10T-LINEBATT
Back up battery kit



S-10T-LINEBLOCF2
Electromechanical lock with side handle
release



S-10T-LINEART
T-line cover opening kit



S-10T-LINE1250
Sliding plate
for framed leaf.
Compatible with
S-10T-LINEPROFI



S-10T-LINE1240
Sliding plate for
crystal leaf



S-T-LINEPROFI
T-line lower
support (2 m
bars)



S-T-LINESPA
Brush seal 4 m

TECHNICAL DRAWINGS

Minimum dimensions for opening the cover with disassembly

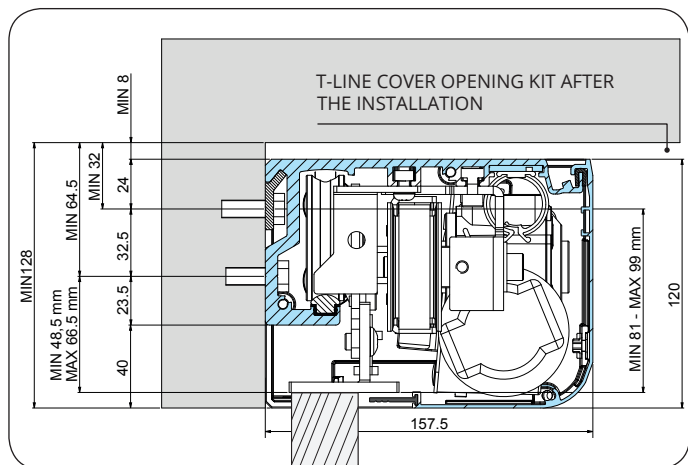

Minimum dimensions for cover opening with articulation kit

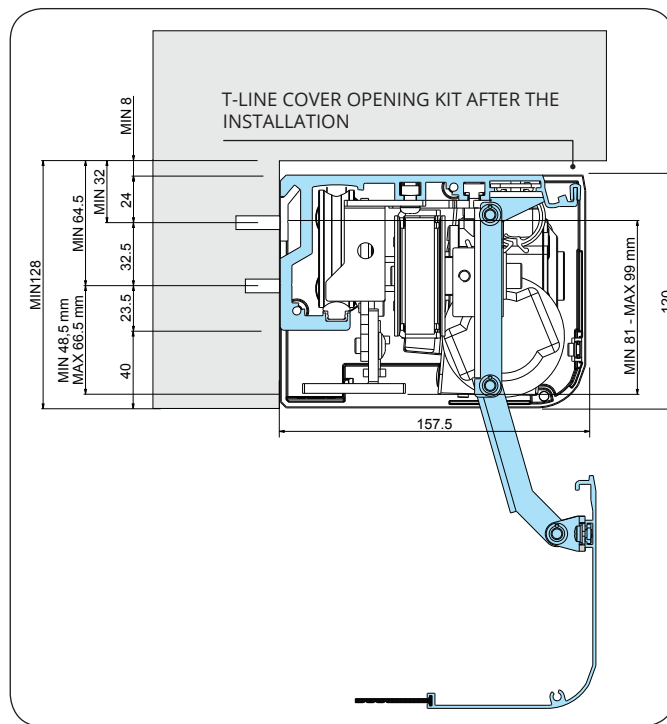

Minimum dimensions for opening the casing upwards

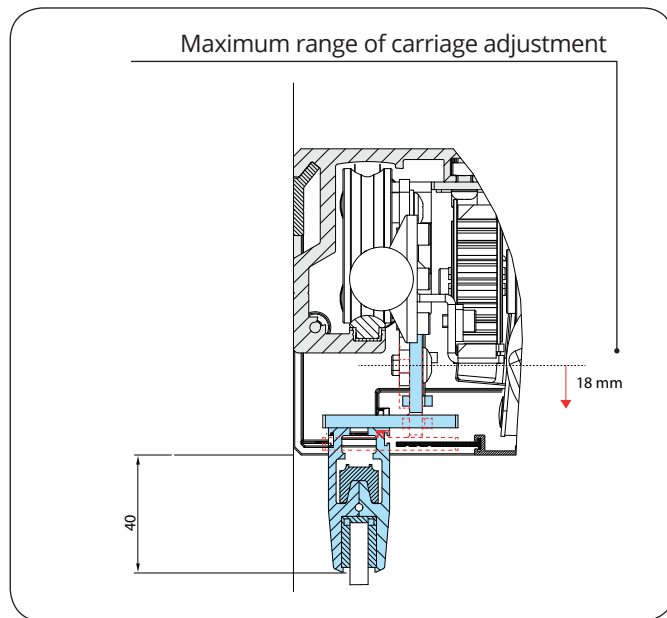
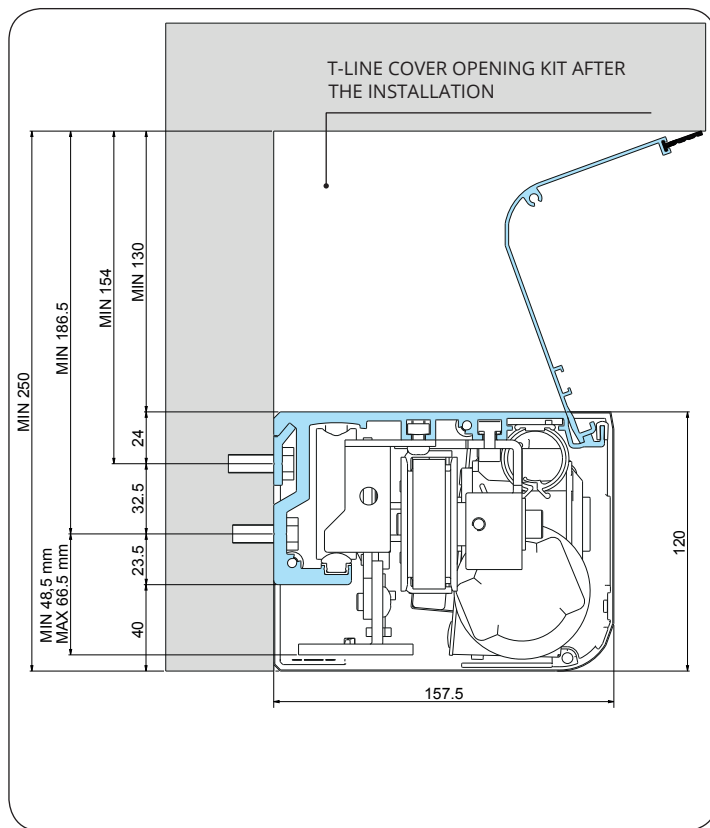

Use and maintenance manuals



TLINEKIT



T-LINE



DC19